





SS-XXXX-155 Series

Safety Approval & Specification



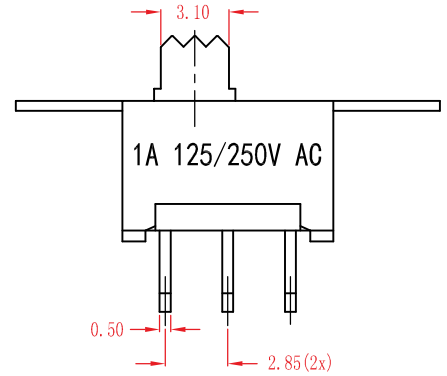
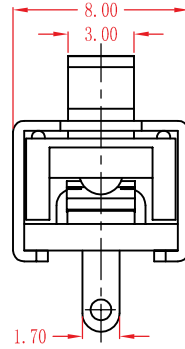
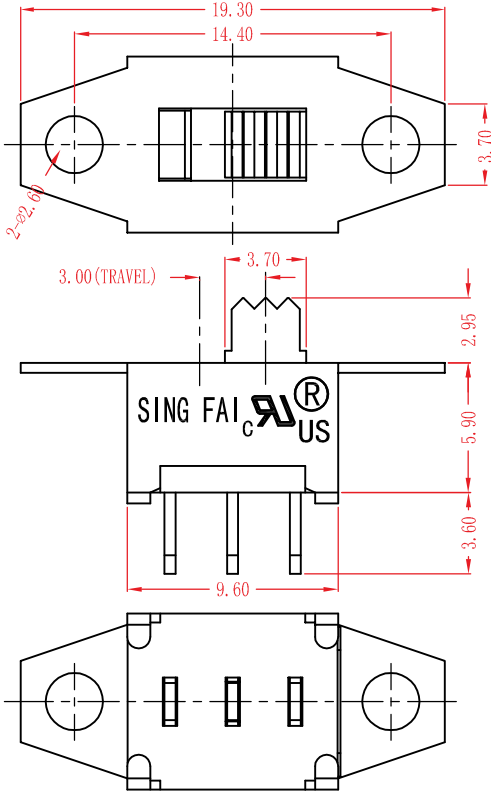



 US UL1054		
3A 125V AC 1.5A 250V AC		
1A 250V AC		

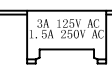
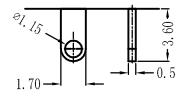

SS — 1 2 0 3 — 155 — 2T ————— A3 ————— C/W ————— E 1

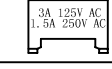
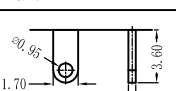
Function	Current
 ON-ON	01 1A 125V AC 1A 250V AC
 ON-OFF	03 3A 125V AC 1.5A 250V AC

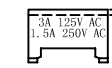
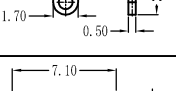
Terminal Number	Remark
2T	Two Terminal ON-OFF
3T	Three Terminal ON-ON

Knob hand Type	Metal Housing Type	Terminal Type
A3 	None 	E1 
A3 二级头 	C/W 	E2 
A5 	C/W 0.5 	E2 
C2 		E4 