

# RT189 Series

## Safety Approval & Specification

		
16A 125V a. c. 8A 250V a. c.	T85	

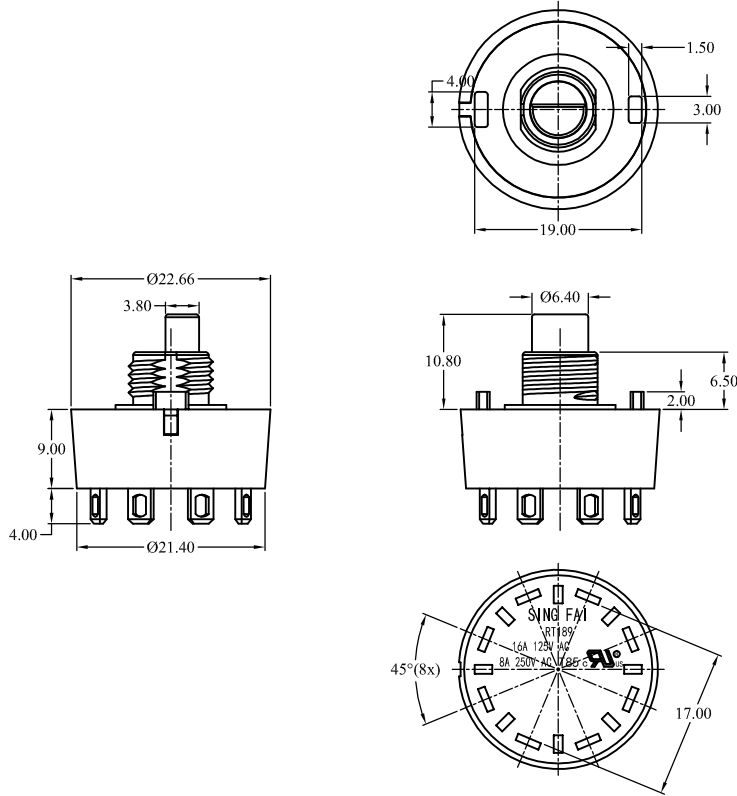

RT189

-24

-16

-A2

-T1

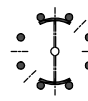
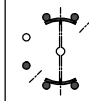
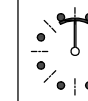
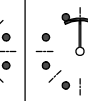
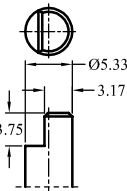
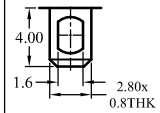
	24	23	22	18	17	Current	Actuator Type	Terminal type
Circuit						16 16A 125V a. c. 8A 250V a. c.	 A1 Ø5.33 3.17 3.75	 T1 4.00 1.6 2.80x 0.8THK
Circuit	