

# RS162 Series

## Safety Approval & Specification

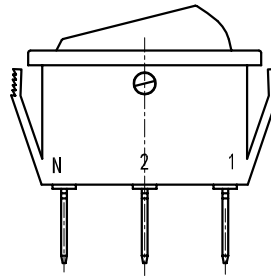

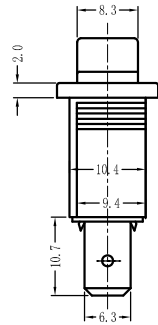

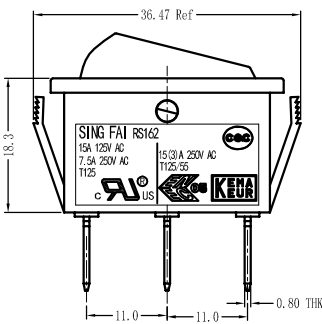
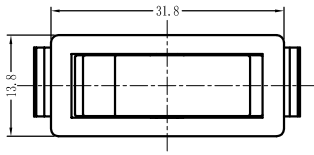

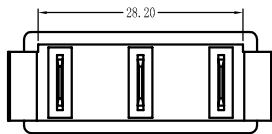
 <b>UL</b> US UL1054	 <b>KEMA</b>	 <b>CCC</b>
15A 125V AC 7.5A 250V AC	T125	15(3)A 250VAC T125/55 15(3)A 250VAC T125/55



Suggested panel hole size  
Nominal Thickness 1.2-3.0mm

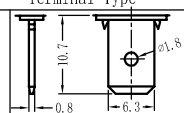

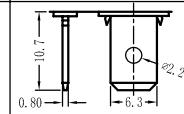
## RS162 -N -15 -1 -K -R -M5 -W -T1

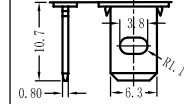
Function	Current	Button Type	Housing Color	Knob Color	Printing	Color of Printing	Terminal Type
A ON-OFF	15 15A 125V AC 7.5A 250V AC	1 	K BLACK W WHITE	K BLACK	0 NONE M22 	O NONE K BLACK W WHITE	T1 
B ON-ON		2 		R RED			
C ON-OFF-ON	15(3)A 250V AC	3 		OR ORANGE			T2 
D (ON)-OFF		I 		T TRANSPARENCE			
E ON-(OFF)							T3 
F ON-(ON)							
M ON-OFF-(ON)							
X (ON)-OFF-(ON)							
N ON-OFF W/lamp (Unswitched neutral)							
P ON-OFF W/lamp (switched neutral)							
I Indicator							