

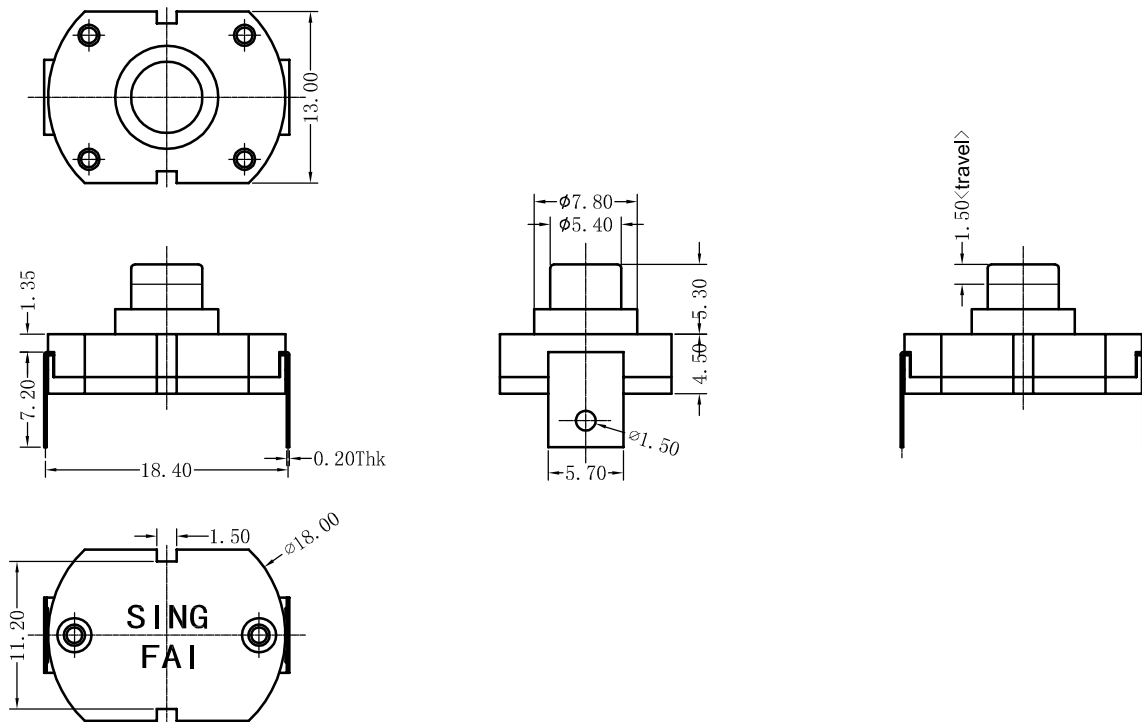



PS-XXXX-150E Series



PS-

| | | | |
|---|---|---|---|
| 1 | 2 | 0 | 1 |
|---|---|---|---|

-150E-02-G5.3

| Function | Current |
|--|---------------|
| 11  PUSH OFF | 01 1A 125V AC |
| 11  PUSH ON | |
| 12  ON-OFF | |

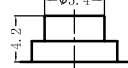
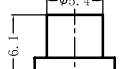
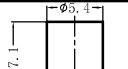
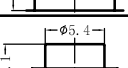
| Terminal Type | | Knob Type | |
|---------------|-----|-----------|---|
| 1101 | 06 | G3.8 |  |
| | | G5.3 |  |
| | | G7.1 |  |
| | | 1101 |  |
| 02 | 062 | | |
| 02 SMALL HOLE | 08 | | |
| 03 | 092 | | |
| 04 | 2AA | | |